

Back to wall toilet

bathco

info@bathcogroup.com

Antequera

Ref. 4570

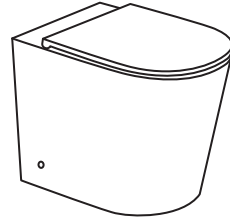

INSTALLATION INSTRUCTIONS

Before proceeding with installation, please read these instructions carefully to familiarise yourself with the required tools, materials and installation sequences. Please leave these instructions for the consumer after installation.

Prior to installation, inspect the toilet to ensure that no damage has occurred in transit. If damage has occurred, or a visible defect exists, do not proceed with installation, and advise your supplier immediately.

CAUTION: risk of personal injury or product damage. Handle with care. Porcelain can be broken or chipped if the product is handled carelessly.

- Observe all local plumbing and building codes.
- Carefully inspect the new toilet for damage.
- If the existing toilet does not have a supply shut-off valve below the cistern, install one before installing the new toilet.

Tools and material required



Tape measure



Level



Safety glasses

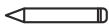

Pencil



Screwdriver



Caulking gun

Installation

- 1** Define the position of the connector. Place the connector onto the pan, and position the connector between the outlet and waste pipe.

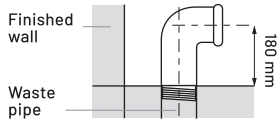
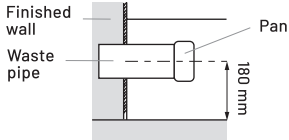

- 2** Using the pencil or template, mark the positions of the floor fixing kit holes.

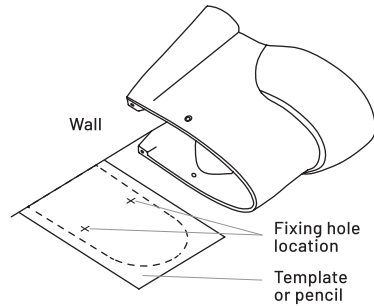

- 3** Fix brackets and water inlet.

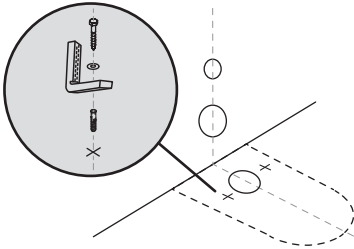

- 4** Ensure that you make a firm connection with inlet and outlet pipes and avoid disturbing the floor fixing brackets.

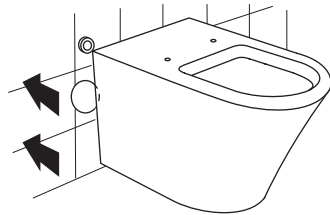

- 5** Insert the washer in the anchor hole of the pan. Then tighten the mounting screw and then put the cap.

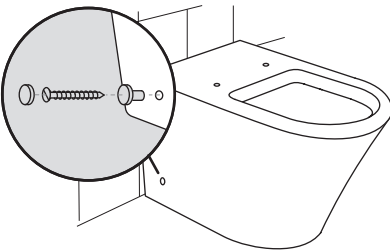

- 6** Fix pan to floor using fixing screws and flexible sealant.

